

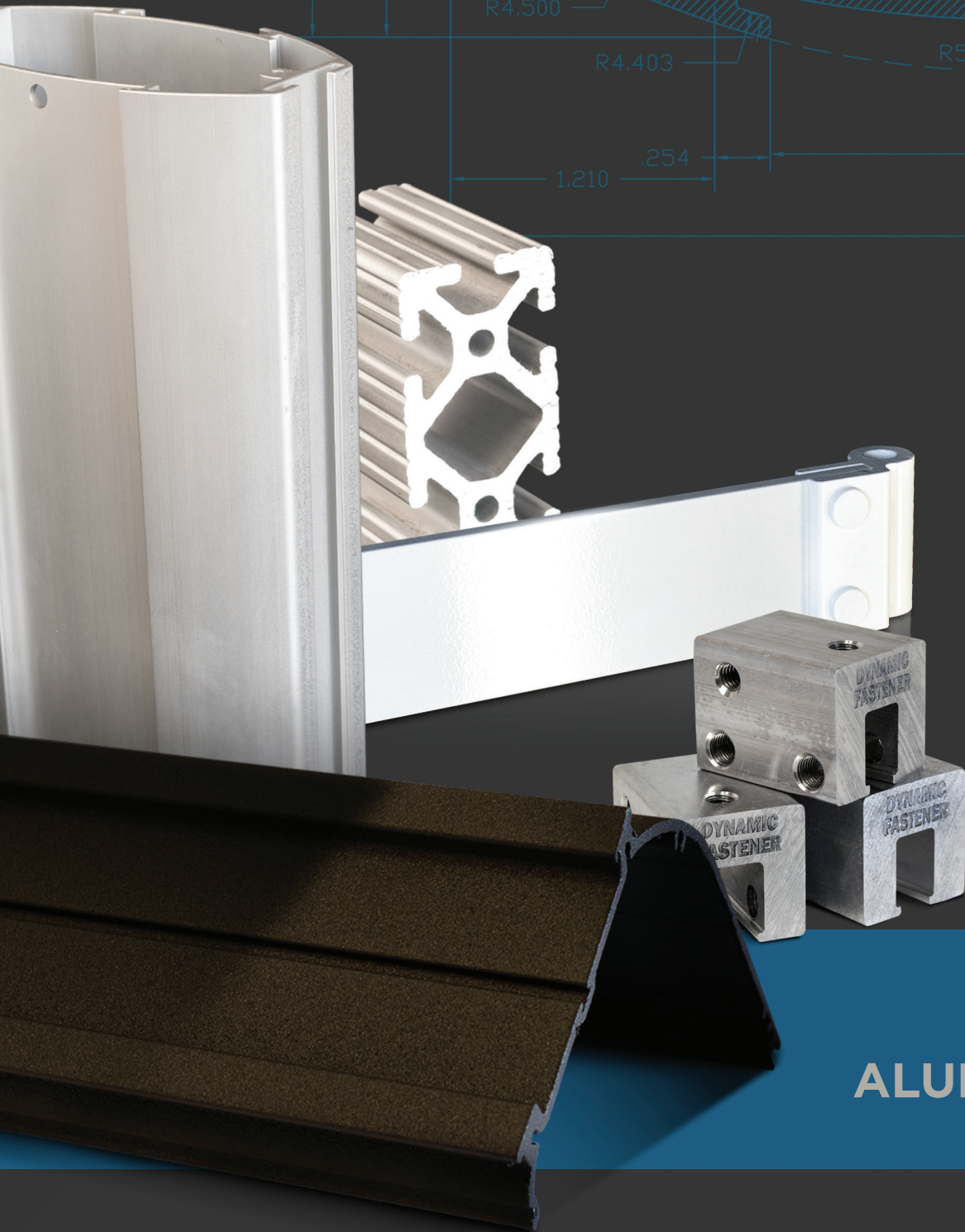

A DIVISION OF AFCO INDUSTRIES, INC.

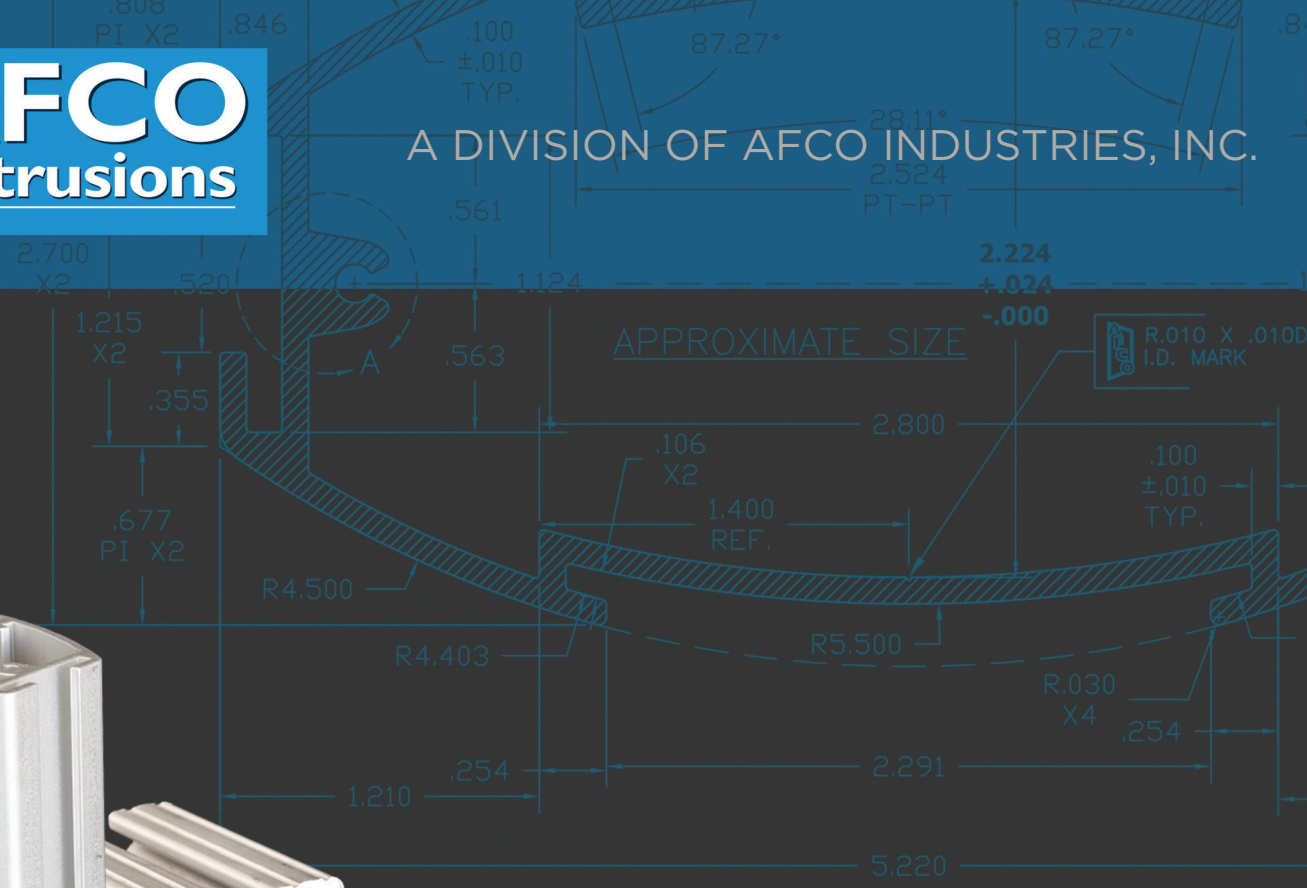

MAKING
ALUMINUM WORK

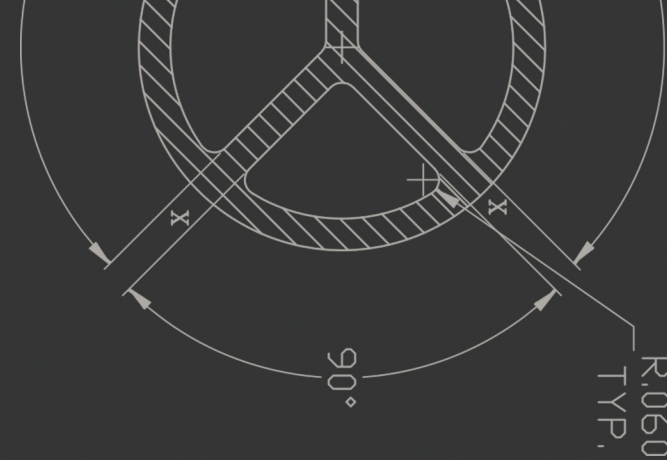

THE ENGINEERING PROCESS

AFCO works with each customer beginning with the design idea. We then create an extrudable shape and make that shape become a reality through the extrusion process.



AFCO begins with a 20' aluminum log and uses a wide variety of alloys and tempers to start the process.

THE EXTRUSION PROCESS

AFCO's 7" Extrusion Presses with automated stretching and cutting capabilities can handle any job.

See **AFCO**
in action



discovered how to electrically reduce bauxite in order to create aluminum. Since 1946, AFCO has been using prime 6000 Series alloys to produce components for some of the world's largest manufacturing companies.

IN 1886, **CHARLES MARTIN HALL**



PRECISION MILLING

Once an extruded shape is created, AFCO has over 15 CNC centers that can fabricate intricate features and details while holding incredibly tight tolerances.

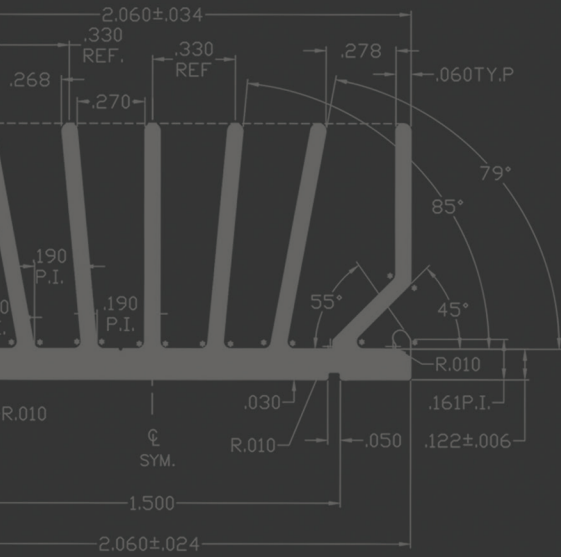

SOME OF AFCO'S SPECIALTIES

Swaging, Grinding, Deburring, Assembly, Bending, Mitering, Turning, Pipe Threading & Custom Packing.



HIGH SPEED SAWING

This high speed automated Granco saw can cut parts quickly and hold very tight length tolerances.

HIGH SPEED DRILLING

AFCO's Robodrills can rapidly tap, countersink and counterbore every job.



VERSATILITY OF MACHINING

AFCO has both horizontal and vertical CNC machines that will produce parts quickly and precisely.



See **AFCO**
in action

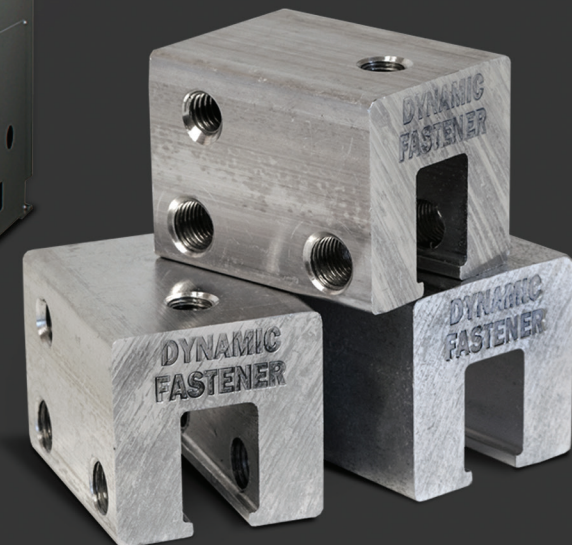

ALUMINUM OFFERS
ENDLESS DESIGN
POSSIBILITIES

AFCO can help you realize the full potential of any manufactured part. We will help you determine which finish is best for the aluminum shape you have created.

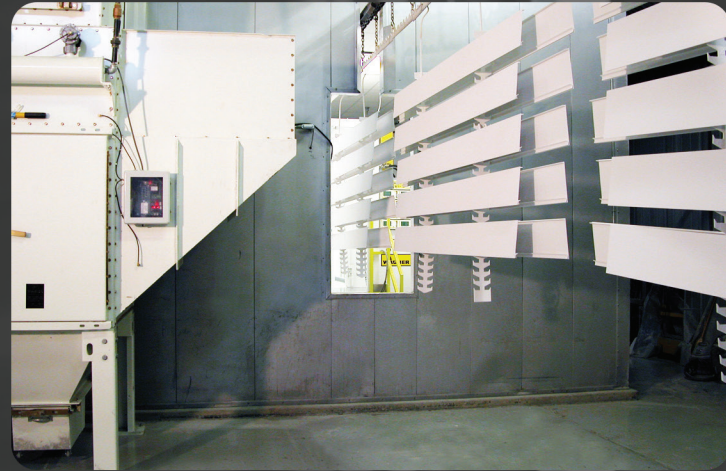

POWDER COAT PAINT

AFCO's state-of-the-art powder coat paint system can change colors in less than 5 minutes and quickly coat any profile up to 25'.

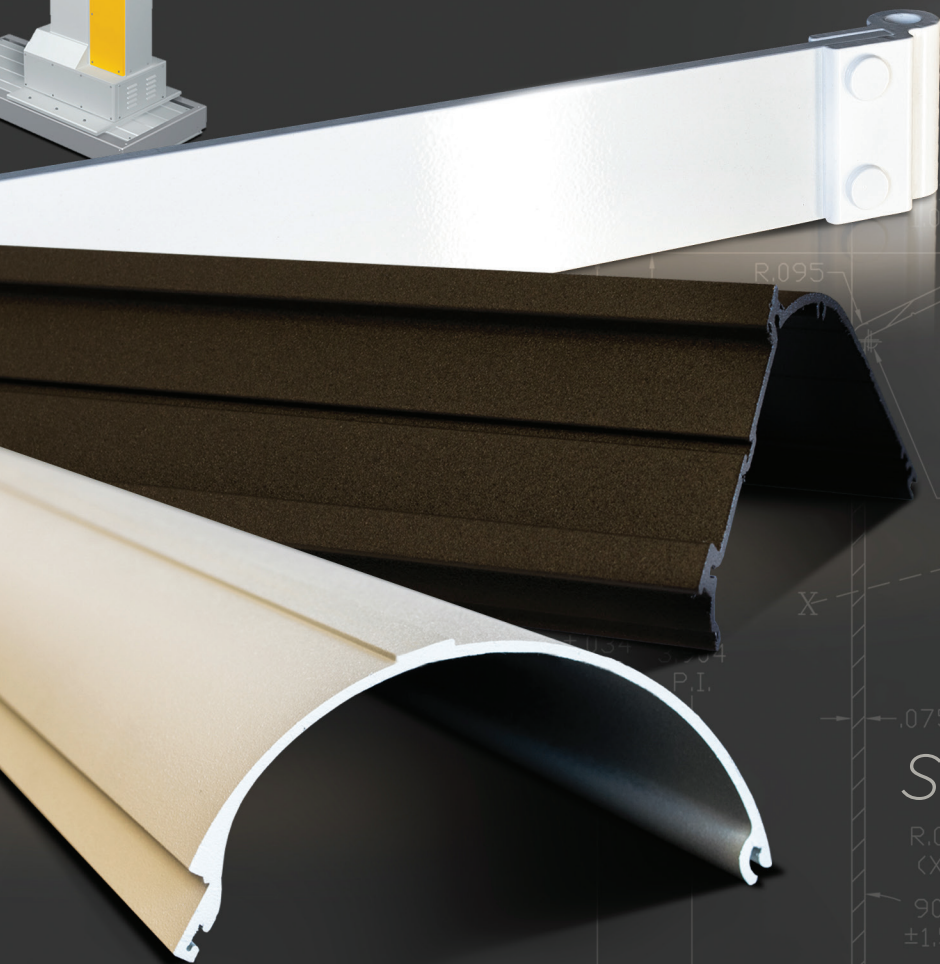

See **AFCO**
in action



CUSTOM FABRICATIONS

Need to move beyond drilling and tapping? With presses from 20 to 150 ton, AFCO can punch or shear any feature. We use the latest welding techniques to add, move or recreate metal from any design. Let AFCO's craftsmen shape and weld to your exact needs.





AFCO Extrusions

3400 Roy Street
ALEXANDRIA, LA 71302

8161 State Highway 37
OLMSTED, IL 62970

PHONE: 800.551.6576
FAX: 318.443.9288

AFCO-IND.COM/CUSTOM-FABRICATION

With presses in Louisiana and Illinois, AFCO Extrusions, a division of AFCO Industries Inc. is a vertically integrated producer.

With over 70 years experience, AFCO utilizes the latest technology to produce custom extrusions.

AFCO Industries, Inc. is an employee-owned manufacturing company with four production facilities located throughout the Greater Mid-South, with manufacturing capabilities in Aluminum, Plastics, Composites and Fiberglass materials.



 LINKEDIN.COM/COMPANY/AFCO-INDUSTRIES-INC

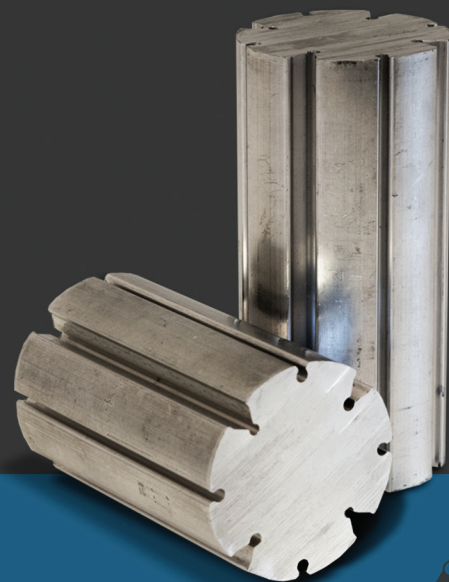
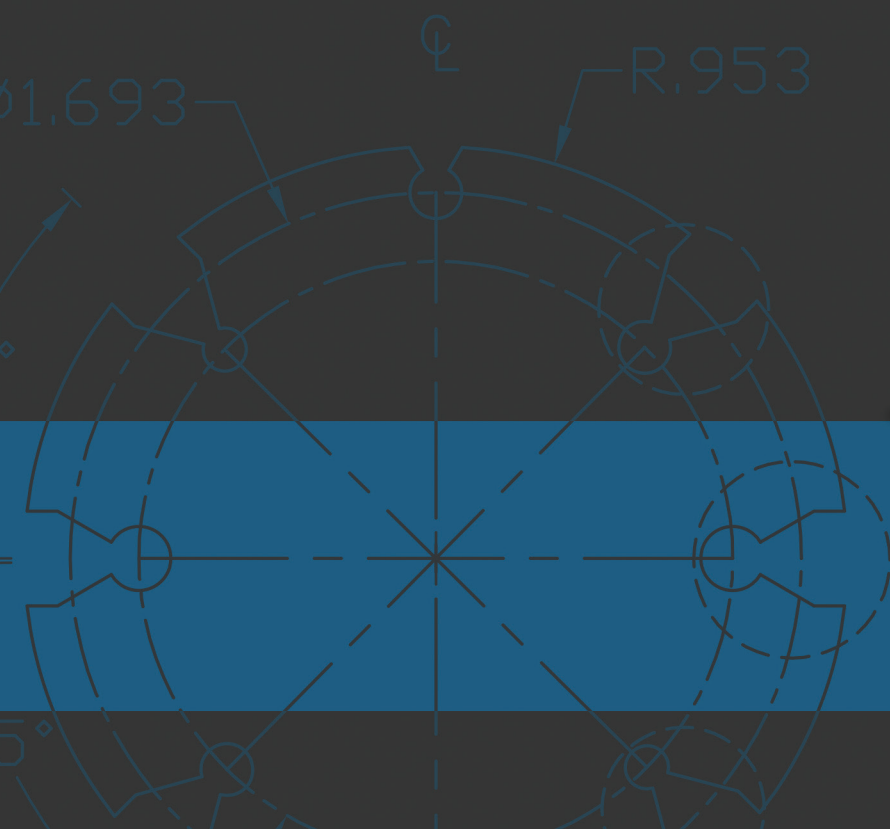

PROUDLY
AMERICAN
★ MADE ★

